

# Morph - Post Arm

Modular double post arm

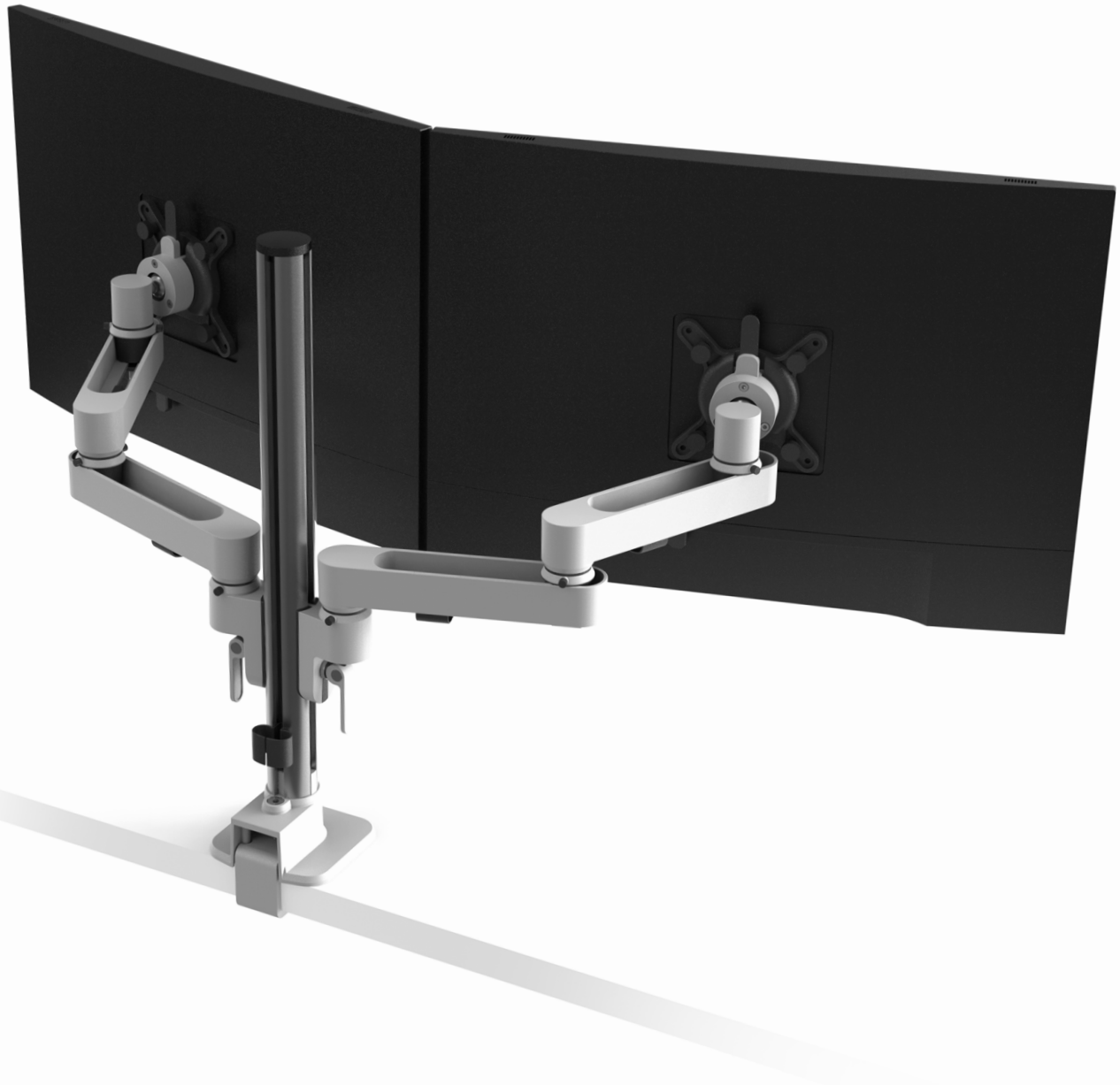

Part of the Morph System:

Morph Post Arm offers full articulation, independent height adjustment of each monitor, infinite height adjustment on the post. Both monitors can be set back to the post giving unparalleled depth control. Can be up-scaled at any time. The unique horizontal slides on the arm allow screens to align in the middle at any depth.

# Morph - Features

## Modular monitor arm

Easy Install Sections of arm slot together without use of hard fixings.

### Fingertip Adjustment

Internal gas spring allows for easy vertical movement of monitors on gas model.

### Full Range of Motion

Vesa ball joint allows for vertical & horizontal tilt of 20-30 degrees, including 360° rotation.

### Complete Depth Control

140mm horizontal arm slide gives adjustment without needing to swing the arm back past the edge of the worktop.

### Quick Release Vesa

Simple push release fin to remove monitors.

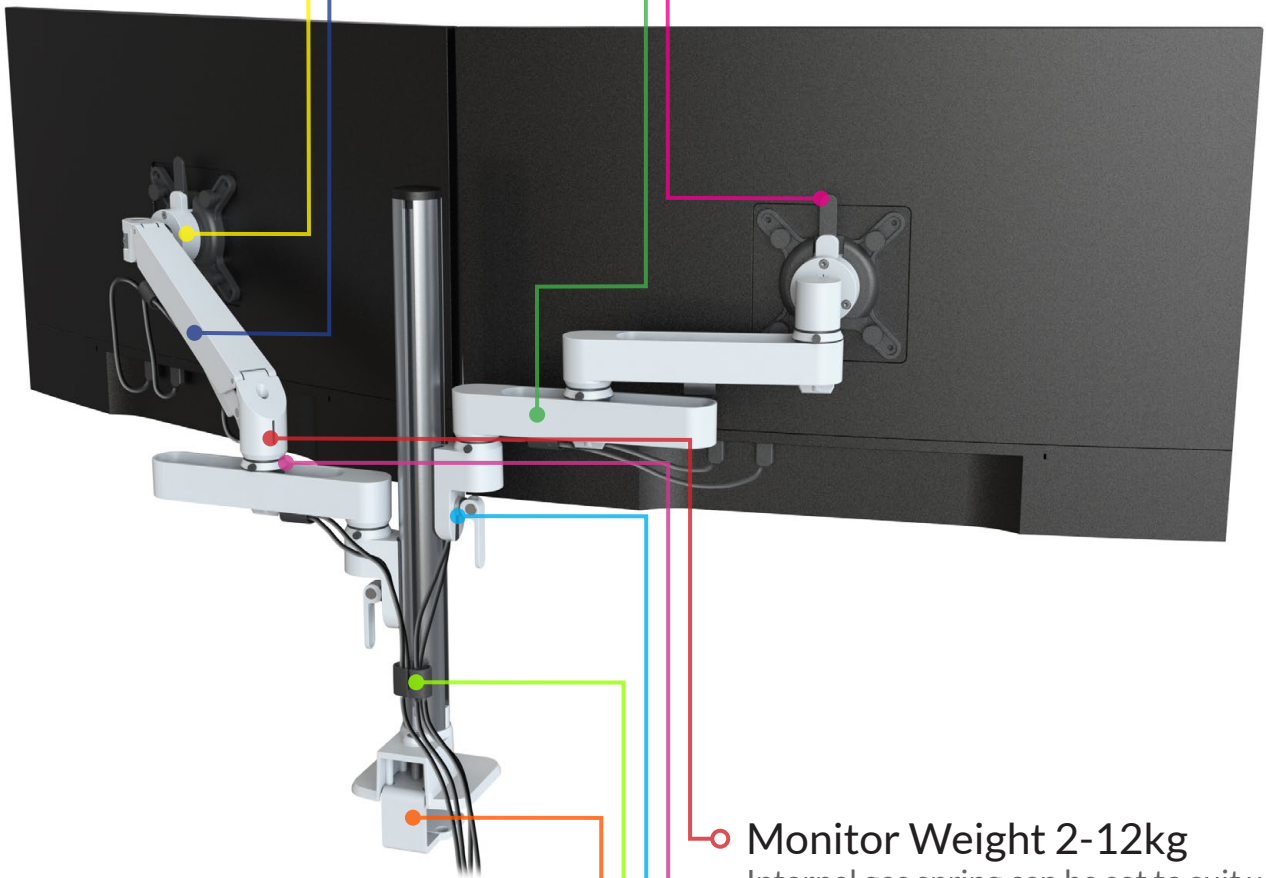

### Top Loading Clamp

Avoids clashes with under-desk items such as cable trays.

Clamp can also be inset to avoid desk screens, can be bolted through worktops and fit through 80mm grommet holes.

### Cable Management

Clips located on each section provide a neat solution to keep cables organised and accessible when you need them.

### Monitor Weight 2-12kg

Internal gas spring can be set to suit weight of monitor.

### Rotation Stopper

Each element has a stopper to limit the swing of the arm. This prevents arms swinging back and damaging vertical surfaces behind.

### Easy Height Adjustment

Cam handle release gives a simple way to move the arm vertically on the central pole, maximising the height adjustment range of the arm.

# Morph - Configurations

Modular monitor arm

## Pole Arm set-ups



1 Monitor, Pole and Vesa Attachment

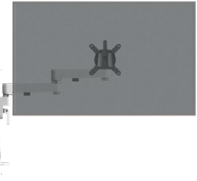

Single Pole Arm

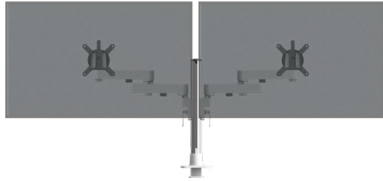

Double Pole Arm

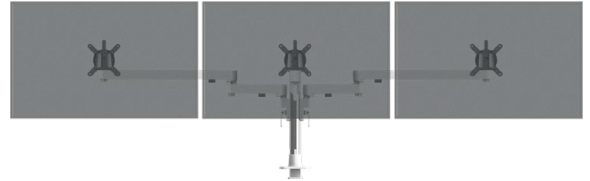

3 Monitor Pole Arm

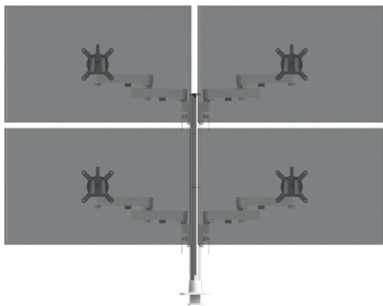

4 Monitor Pole Arm

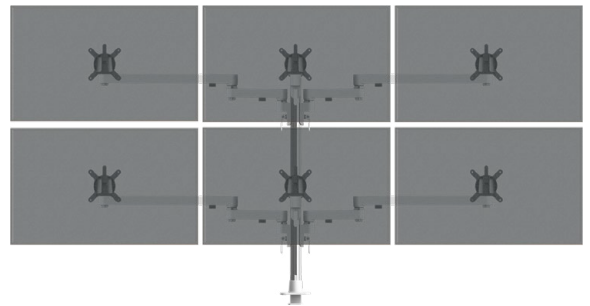

6 Monitor Pole Arm

## Gas Arm set-ups



Single Gas Arm

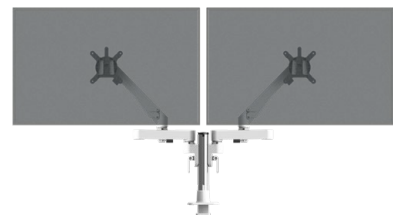

Double Gas Arm

## Mixed Arm set-ups

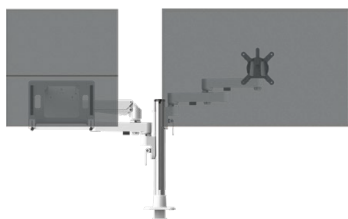

1 Monitor, 1 Laptop Tray

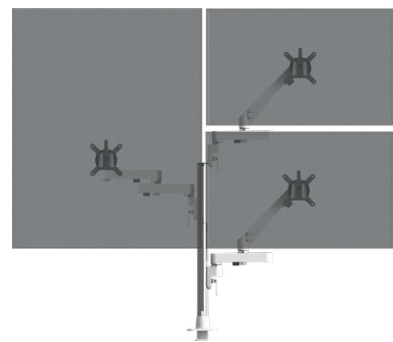

2 Monitor Pole arm, Single Gas Arm

# Morph - Post Arm

Modular post arm

White:



Black:



Silver:



# Morph - Post Arm

Modular post arm

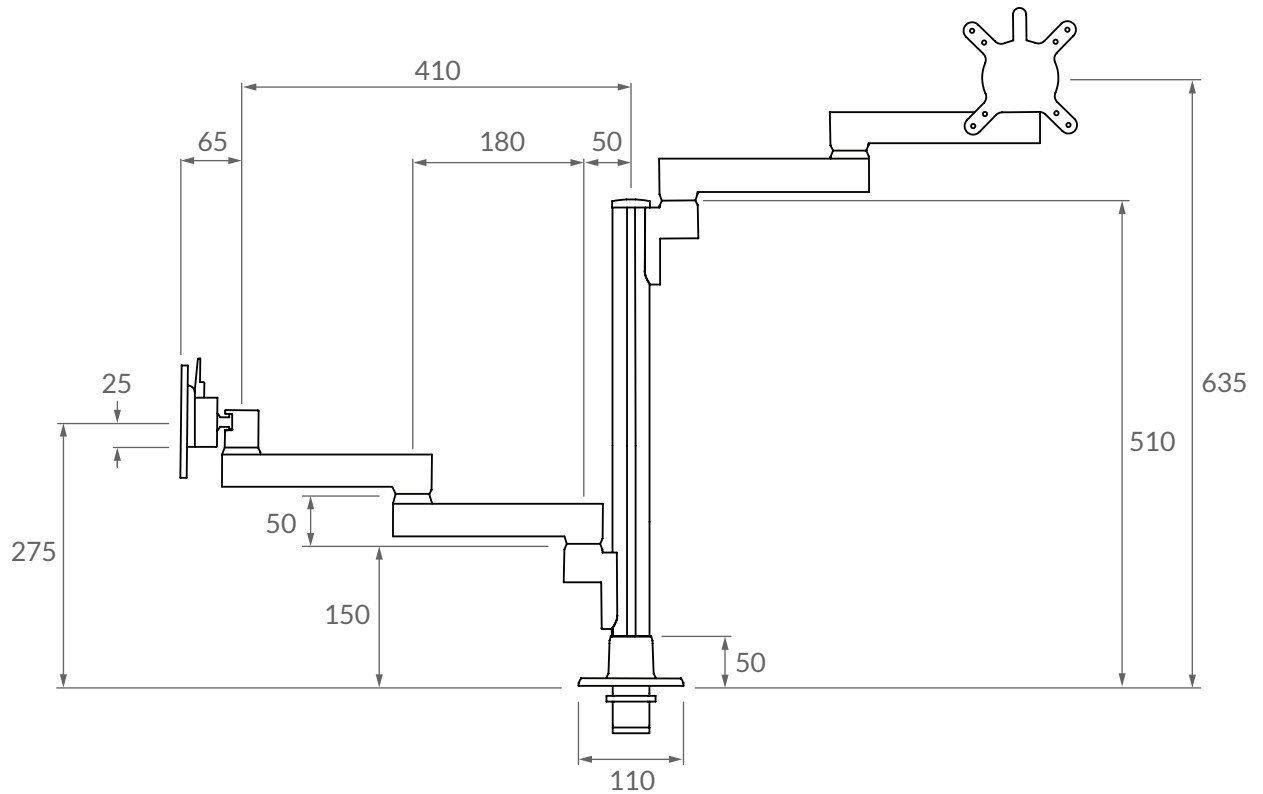

\* All measurements in mm

## Horizontal Arm Slide

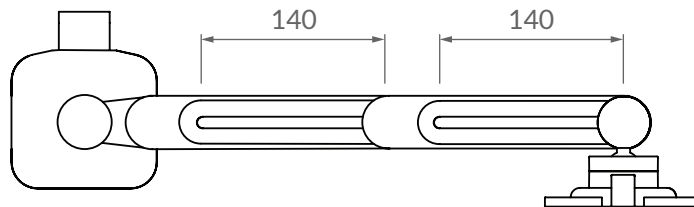

## Base

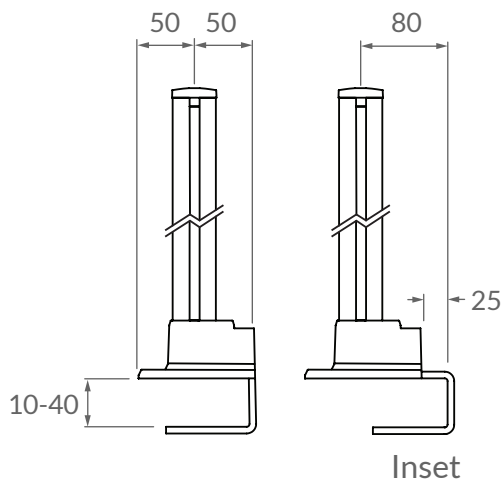

Inset

## Non-standard Arms

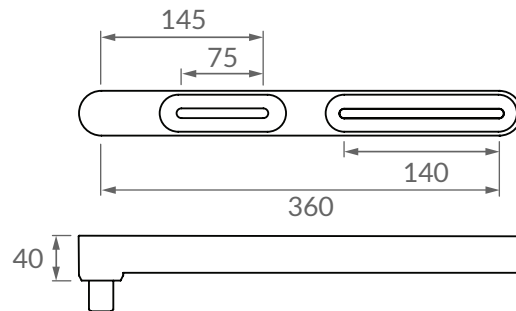

# Morph - Parts

Modular monitor arm

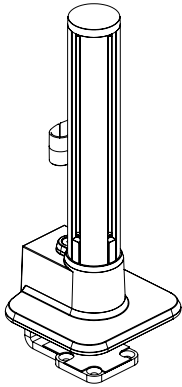

## Short Base

Short Post with Base/ Clamp. Can be extended with additional Post.

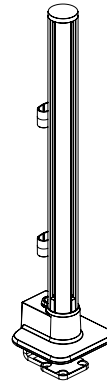

## Long Base

Long Post Section with Base/ Clamp. Can be extended with additional Post.

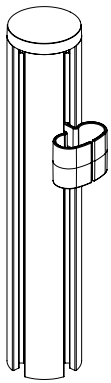

## Post Extension short

Short Post (200mm) with Cable Clip. Can be used to extend Post height.

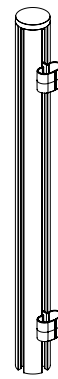

## Post Extension Long

Long Post (450mm) with Cable Clips. Can be used to extend Post height.

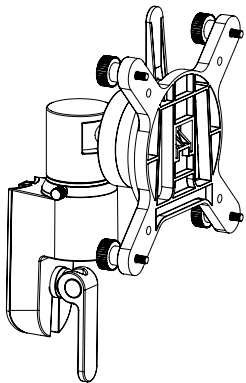

## Post Mount

Fits into post channel 75mm & 100mm Vesa compliant.

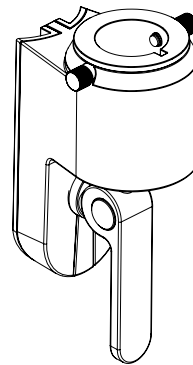

## Socket Slider

Fits into Post channel. Compatible with Arms and Vesa Head.

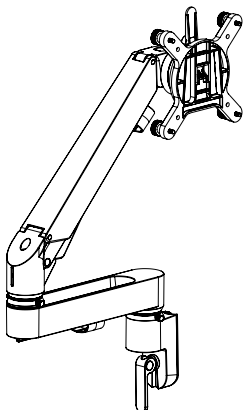

## Gas Arm

Fits into Long or Short Base.

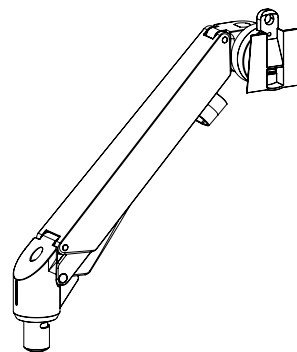

## Gas Section

Compatible with Arm Section and Socket Slider. Can be fitted with Vesa Set.

# Morph - Parts

Modular monitor arm

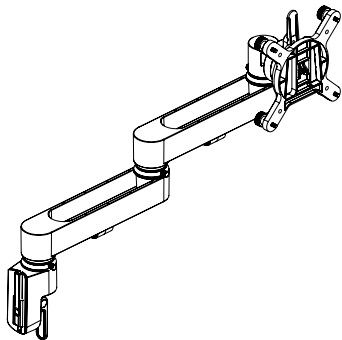

## Post Arm

Fits into post channel on Base. Can be fitted with Additional Arms & Vesa mounts.

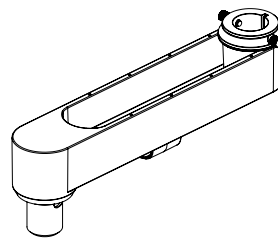

## Arm Section 1

Compatible with Vesa Head, Socket Slider, Gas Section and Arm Section. Can be fitted with additional Arms & Vesa mounts.

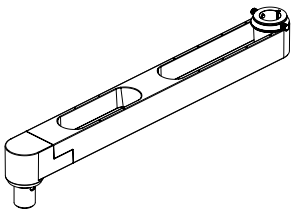

## Arm Section 2

Medium Arm section. Comes with Arm Slider.

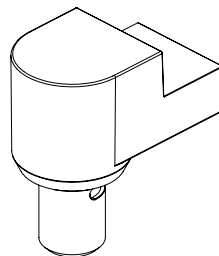

## Connect Element

For use with arm extensions and bespoke solutions.

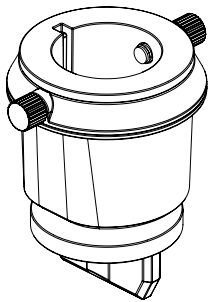

## Arm Slider

Fits into Arms. Can be fitted with additional Arms and Vesa Heads. Slides along track and can be locked in position.

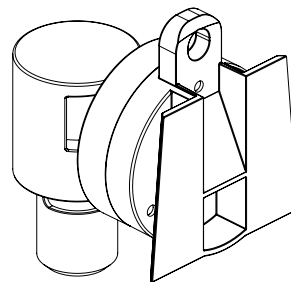

## Vesa Head

Compatible with Socket Sliders and Arm Sliders. Can be fitted with Vesa Set.

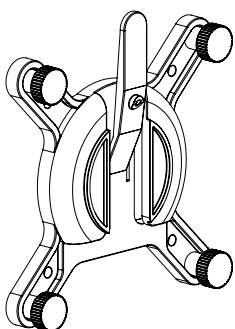

## Vesa Set

Compatible with Post and Gas Assisted Arms. 75mm & 100mm Vesa compliant.

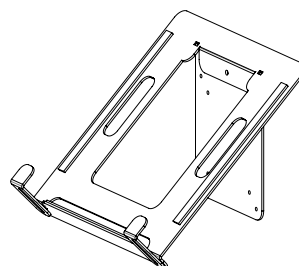

## Laptop Tray

Laptop tray, can be fitted to Vesa attachment.