

# Eyelet Round

In desk module



# Eyelet Round

In desk module



Grey/ Stainless Steel



Black/ Stainless Steel



Black/ Black



White/ White



White/ Stainless Steel

Fitting a standard  $\text{Ø}80\text{mm}$  cut out - the Eyelet provides a selection of power and data outlets. The high quality stainless steel face plate can be personalised to a range of colours and finishes. This innovative product makes use of the frequently vacant cable ports within desks.

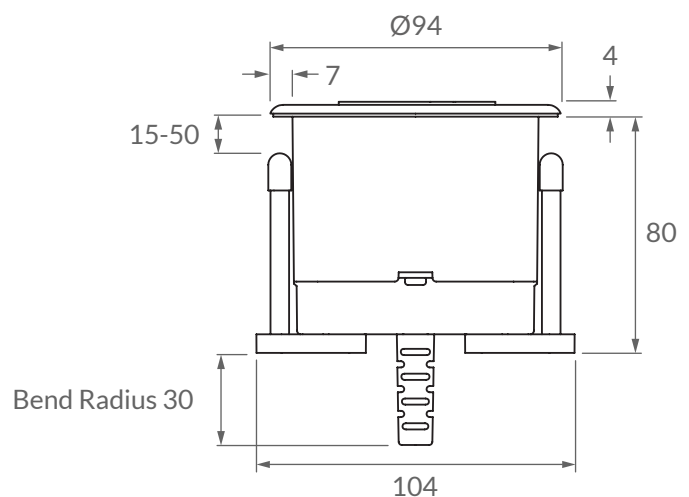
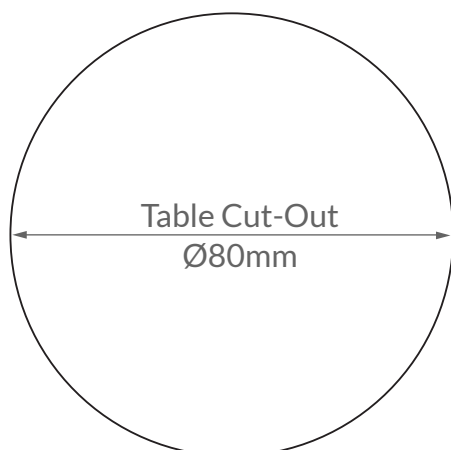

\*All measurements in mm

# Eyelet - Outlets

In desk options

## Power

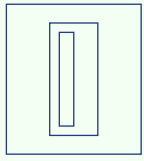

USB-A 18W

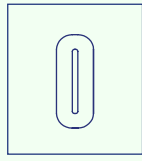

USB-C 18W

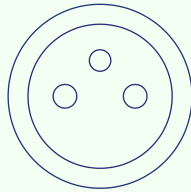

Type E (French)

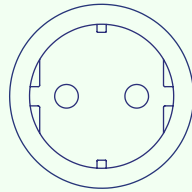

Type F (Schuko)

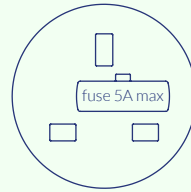

Type G (UK) Fused

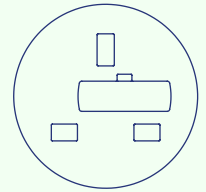

Type G (UK) Unfused

## Shape Options

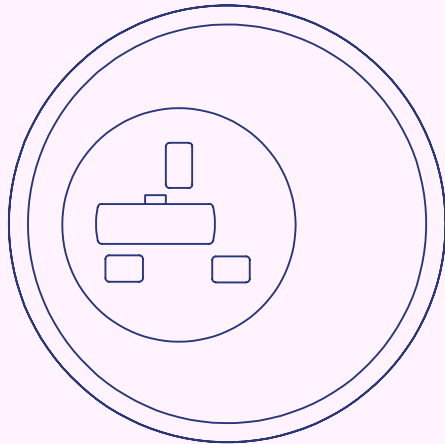

Eyelet Round

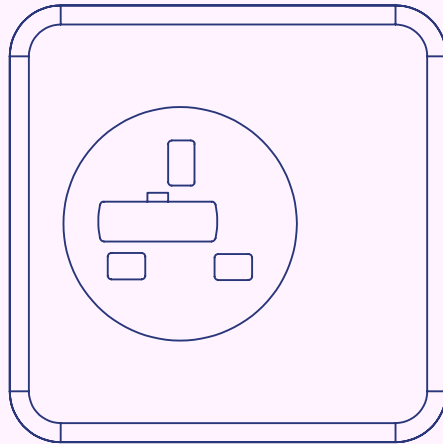

Eyelet Square

## 5 Keystone AV Option

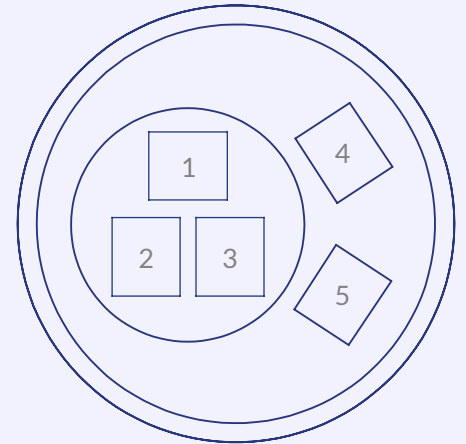

Round or Square, up to 5 Keystone

## Number of Keystone Outlets

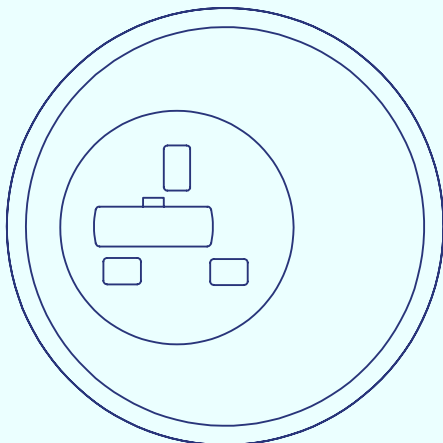

No Outlets

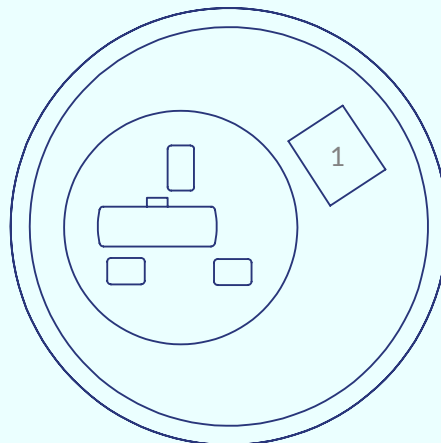

One Outlet

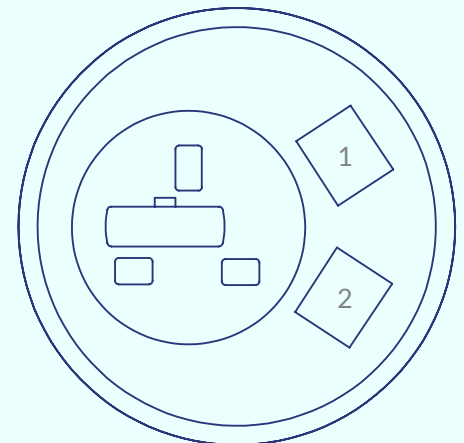

Two Outlets

## Data & AV Keystone

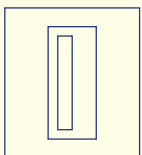

USB-A

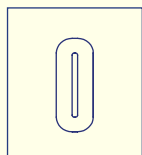

USB-C

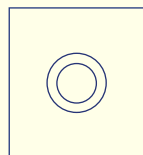

Audio

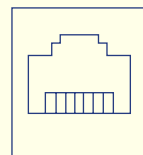

Data

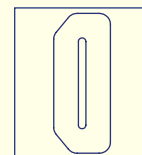

HDMI

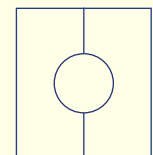

Pull Through